

**Auden™**  
LF-042-AD

Single Control Faucet  
Grifo de Solo Control  
Robinet de Commande Simple

Quick Installation Guide  
Guía de Instalación Rápida  
Guide d'Installation Rapide



Installation Support • Soporte de Instalación • Support d'Installation

Personal Assistance, Product Specs, & "How-to" Questions:

Asistencia personal, especificaciones del producto y preguntas sobre "cómo hacerlo":

Aide personnelle, spécifications du produit et questions « pratico-pratiques » :

**1-800-PFAUCET (732-8238)**  
**pfisterfaucets.com/support**

Installation Videos Available  
Videos de instalación a disposición  
Vidéos d'installation disponibles



pfisterfaucets.com/videos



**WARNING / ADVERTENCIA / AVERTISSEMENT**

**To reduce the risk of injury or property damage, read all instructions before installing product. Wear safety goggles. Product must be installed in accordance with all state & local plumbing & building codes. Call a professional if you are uncertain about installing this product.**

Para disminuir el riesgo de lesiones o daños a la propiedad, lea todas las instrucciones antes de instalar el producto. Utilice gafas de seguridad. El producto deberá instalarse de acuerdo con la normativa de plomería y construcción estatal y local. Llame a un profesional si no está seguro sobre cómo instalar este producto.

Pour réduire le risque de blessures ou de dommages, lire toutes les instructions avant d'installer le produit. Porter des lunettes de sécurité. Le produit doit être installé en conformité avec tous les codes de construction et de plomberie locaux et de l'état. Appelez un professionnel si vous n'êtes pas certain de la façon d'installer ce produit.

## Required Tools

Herramientas necesarias  
Outils nécessaires

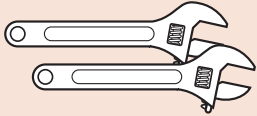

Adjustable Wrenches  
Llaves ajustables  
Clés à molette

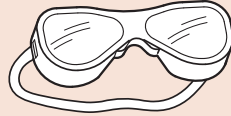

Safety Goggles  
Gafas de seguridad  
Lunettes de sûreté

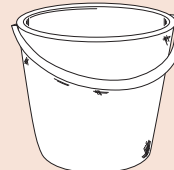

Bucket  
Balde  
Seau

## Additional Helpful Tools

Otras herramientas útiles  
Outils supplémentaires utiles

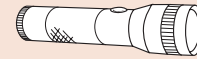

Flashlight  
Linterna  
Lampe De Poche



Cloth  
Paño  
Chiffon

## Parts in the Box

Piezas en la caja  
Pièces dans la boîte

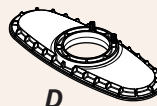
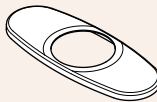
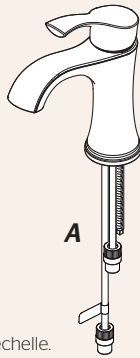

G (x2)

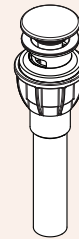

H



Aerator Tool  
Herramienta aireador  
Outil d'aérateur

Items shown are not to scale.  
De resultados no están a escala.  
Produits affichés ne sont pas à l'échelle.

## 1 Turn Off Water Supply • Cierre el suministro de agua • Couper l'alimentation en eau



**Locate water supply inlets and shut off the water supply valves. These are usually found under the sink or near the water meter. If you are replacing an existing faucet, remove the old faucet from the sink and clean the sink surface thoroughly.**

Ubique las entradas del suministro de agua y cierre las válvulas de suministro de agua. Generalmente se encuentran debajo del fregadero o cerca del medidor de agua. Si se trata de un reemplazo de grifo, quite el grifo viejo y limpie completamente la superficie del fregadero.

Recherchez les entrées d'approvisionnement et fermez leurs robinets. Ces robinets se trouvent généralement sous l'évier ou près du compteur d'eau. Si vous remplacez un robinet existant, retirez, le vieux robinet de l'évier et nettoyez soigneusement la surface de ce dernier.

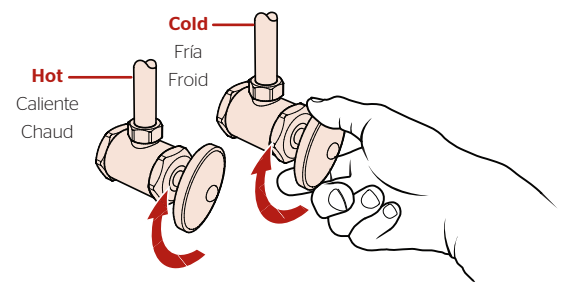

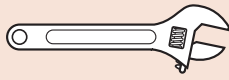
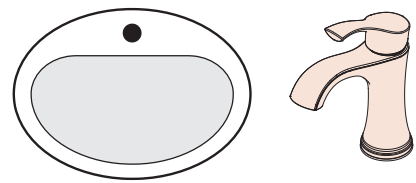
**2****OPTION 1: Install Faucet without Deckplate****OPCIÓN 1: Instale el grifo sin la placa de cubierta****OPTION 1: Installer le robinet sans le plate-forme**

Adjustable Wrench  
Llave ajustable  
Clé réglable

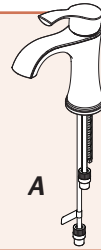
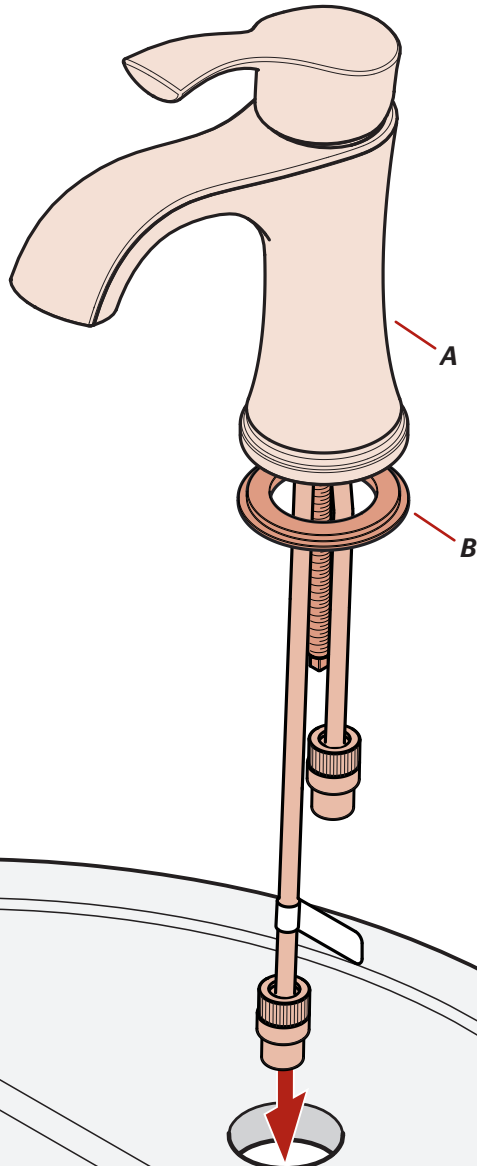
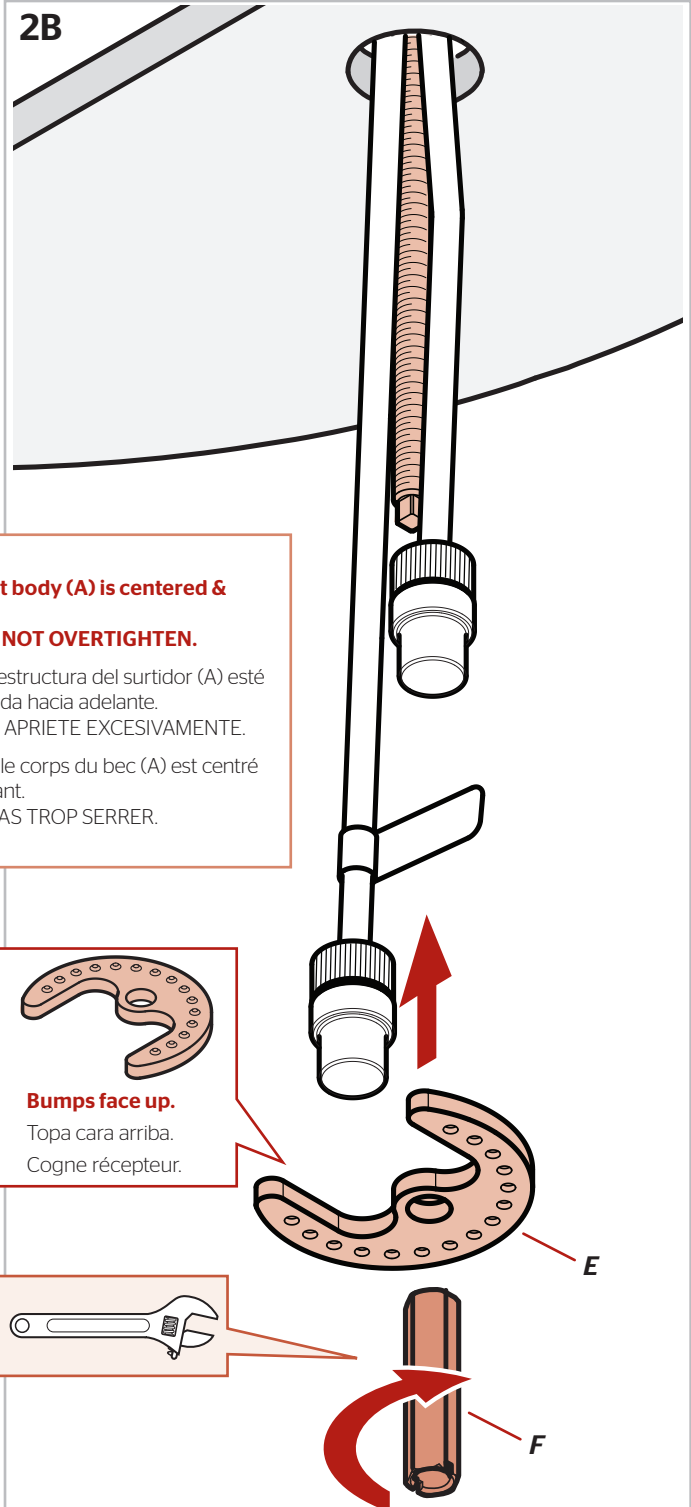
**A****B****E****F****2A****2B**

**Be sure the spout body (A) is centered & facing forward.  
IMPORTANT: DO NOT OVERTIGHTEN.**

Cerciórese que la estructura del surtidor (A) esté centrada y orientada hacia adelante.  
IMPORTANTE: NO APRIETE EXCESIVAMENTE.

Assurez-vous que le corps du bec (A) est centré et tourné vers l'avant.  
IMPORTANT: NE PAS TROP SERRER.

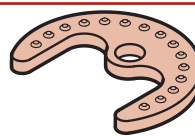

**Bumps face up.**

Topa cara arriba.

Cogne récepteur.



**3** **OPTION 2: Install Faucet with Deckplate**  
**OPCIÓN 2: Instale el grifo con la placa de cubierta**  
**OPTION 2 : Installer le robinet avec le plate-forme**

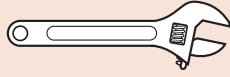
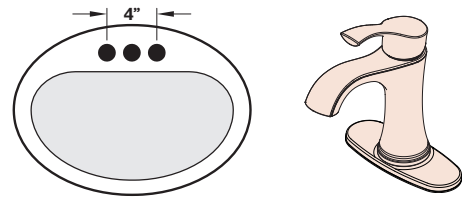

Adjustable Wrench  
 Llave ajustable  
 Clé réglable

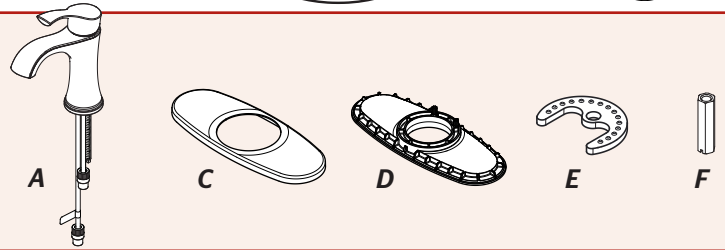

**3A**

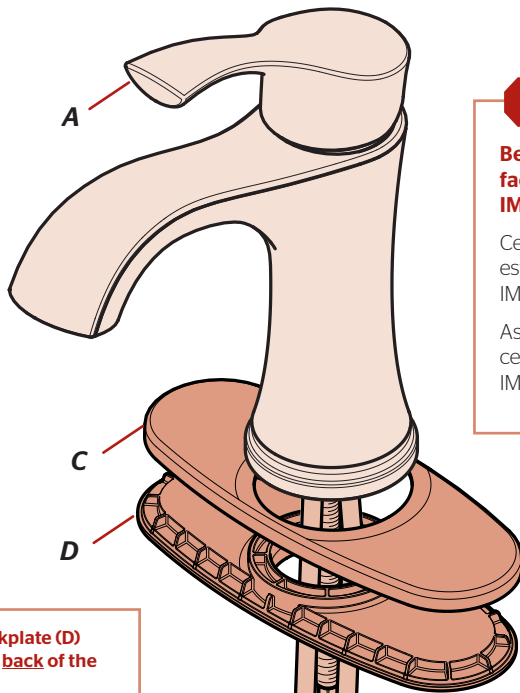

**!** **Ensure posts of the Deckplate (D) aligns with holes on the back of the Faucet (A).**

Asegúrese de que los postes de la placa de cubierta (D) se alineen con los agujeros en la parte posterior del grifo (A).

Assurez-vous que les montants de la plaque de pont (D) sont alignés avec les trous à l'arrière du robinet (A).

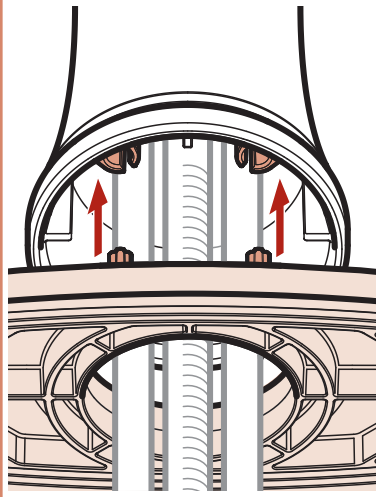

**3B**

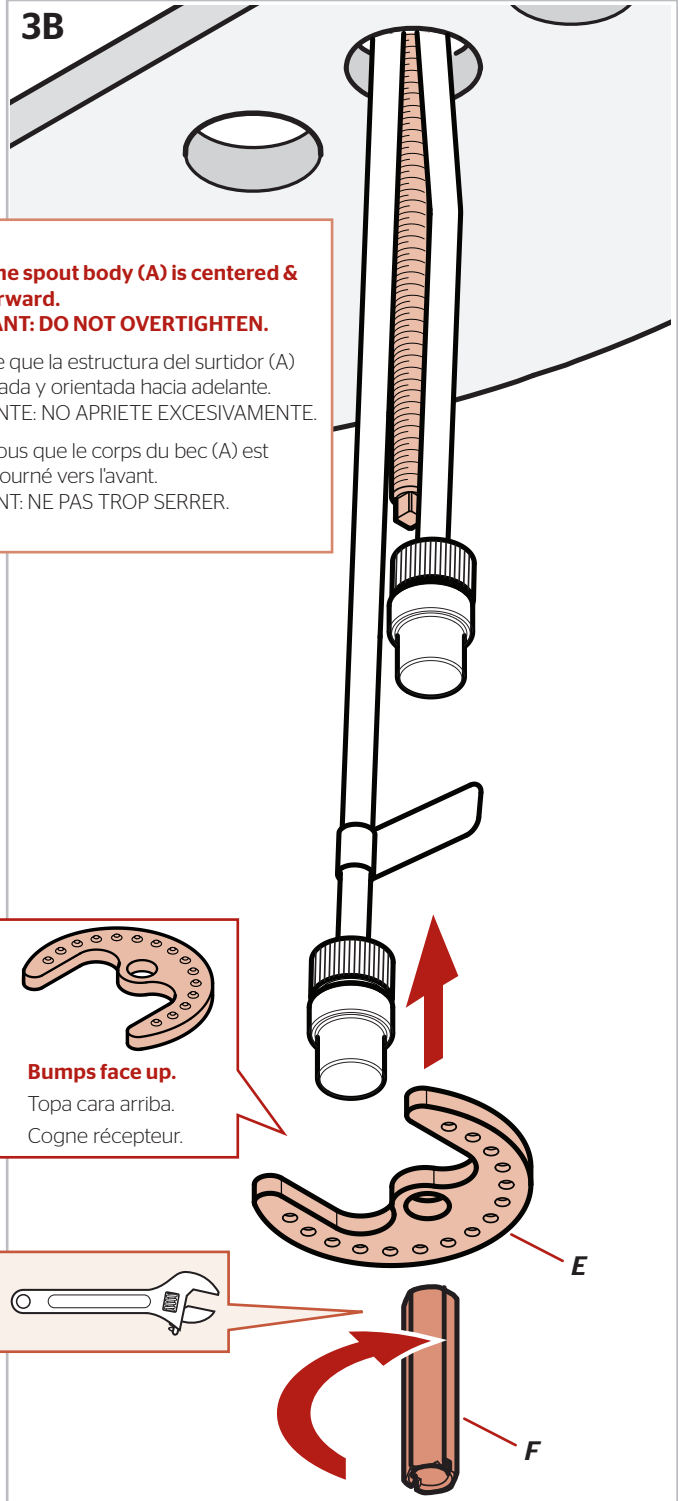

**!** **Be sure the spout body (A) is centered & facing forward. IMPORTANT: DO NOT OVERTIGHTEN.**

Cerciórese que la estructura del surtidor (A) esté centrada y orientada hacia adelante. **IMPORTANTE: NO APRIETE EXCESIVAMENTE.**

Assurez-vous que le corps du bec (A) est centré et tourné vers l'avant. **IMPORTANT: NE PAS TROP SERRER.**

**Bumps face up.**  
 Topa cara arriba.  
 Cogne récepteur.

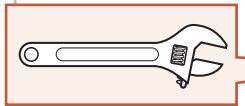

# 4 Connect Water Supply Lines

## Conecte las tuberías de suministro de agua

### Raccorder les conduites d'alimentation en eau

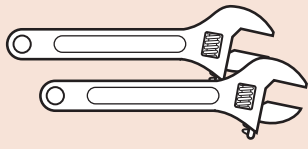

Adjustable Wrenches  
Llaves ajustables  
Clés à mollette

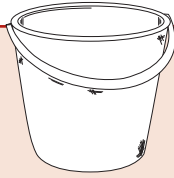

Bucket  
Balde  
Seau



G (x2)

**Water Supply Lines not included. Please consult manufacturer and/or its instructions for the correct method of installation of supply lines & fittings.**

**IMPORTANT: Incorrect application of supply lines and fittings may result in the failure or leak of the supply lines and fitting.**

Las tuberías de suministro de agua no están incluidas. Consulte por favor el fabricante y/o sus instrucciones para el método correcto de instalación de líneas de suministro y de guarniciones.

**IMPORTANT:** El uso incorrecto de líneas de suministro y de guarniciones puede dar lugar a la falta o al escape de las líneas de suministro y de la guarnición.

Les tuyaux d'arrivée d'eau ne sont pas fournis. Veuillez consulter le fabricant et/ou ses instructions pour la méthode correcte d'installation des conduites d'alimentation en eau et des accessoires.

**IMPORTANT:** Mauvaise application des lignes d'alimentation et accessoires peut entraîner la défaillance ou la fuite.

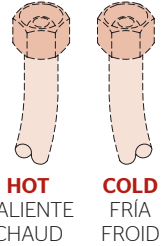

**HOT**  
CALIENTE  
CHAUD

**COLD**  
FRÍA  
FROID

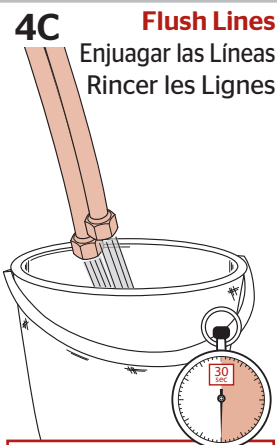
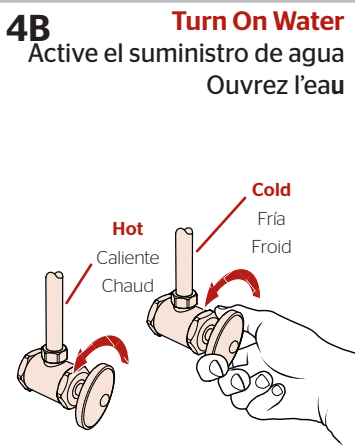
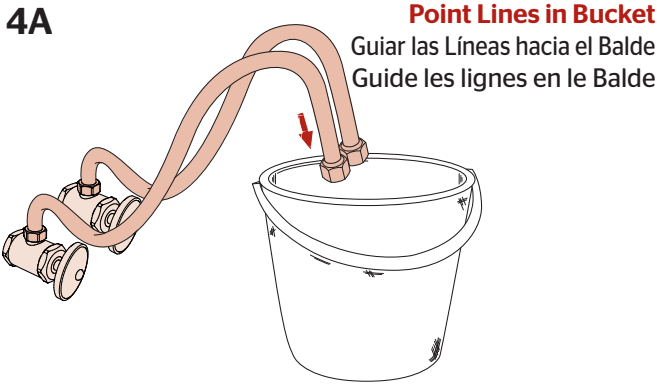

**Allow water to run for at least 30 seconds.**

Deje correr el agua durante al menos 30 segundos.  
Permettez à l'eau couler au moins 30 secondes.

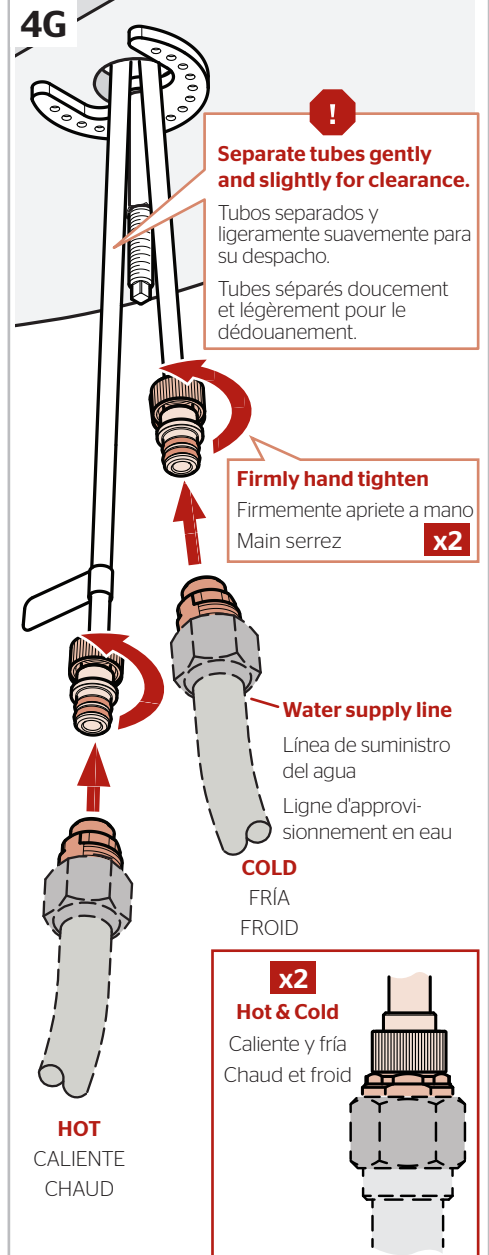
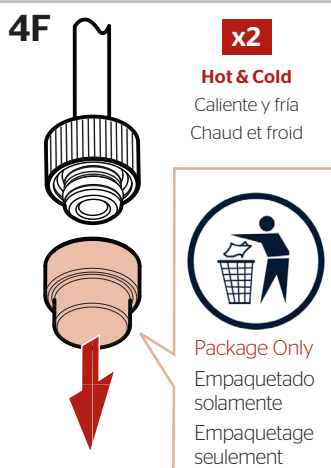
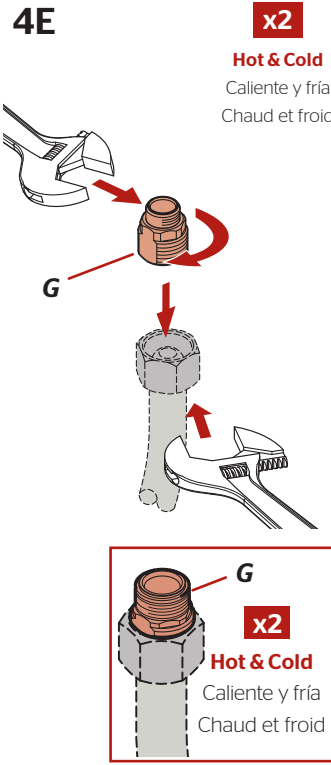
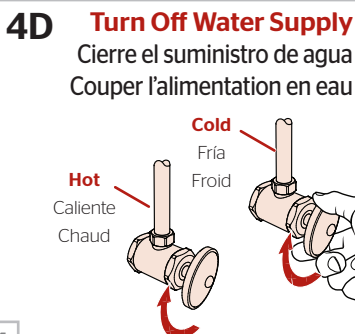

# 5 Prepare & Install Push & Seal™ Drain

## Prepare y instale cuerpo de drenaje Push & Seal™

### Préparez & installez le corps de drainage Push & Seal™

No Tools Required for This Step  
 No se necesitan herramientas para este paso  
 Pas d'outil nécessaire pour cette étape

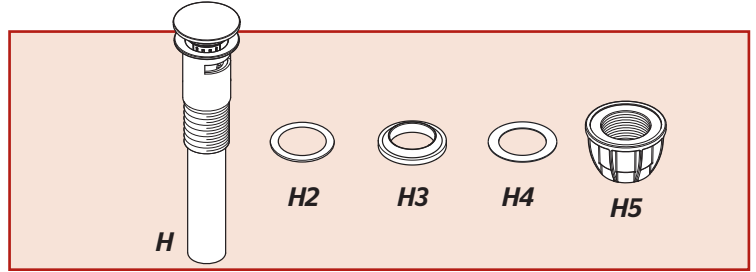

#### 5A Disassemble Pop-Up

#### Desensamble el cuerpo de drenaje

#### Démontez le corps de drainage

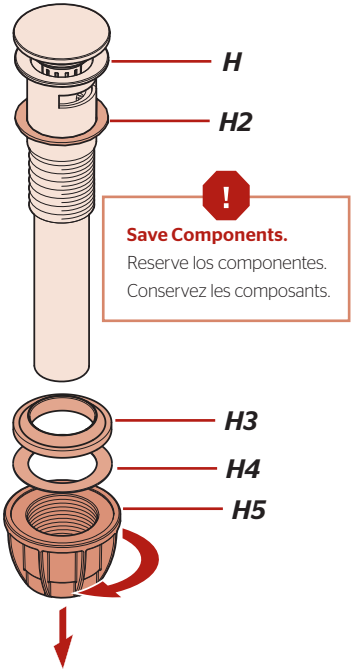

**Save Components.**  
 Reserve los componentes.  
 Conservez les composants.

#### 5B

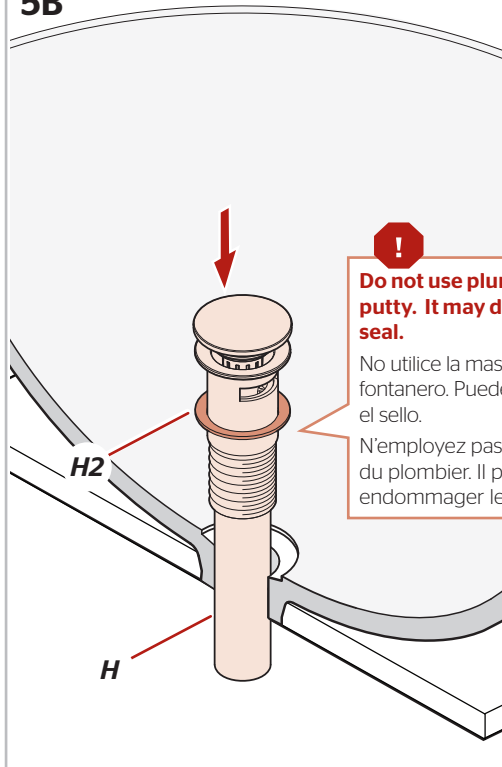

**Do not use plumber's putty. It may damage seal.**  
 No utilice la masilla del fontanero. Puede dañar el sello.  
 N'employez pas le mastic du plombier. Il peut endommager le joint.

#### 5C

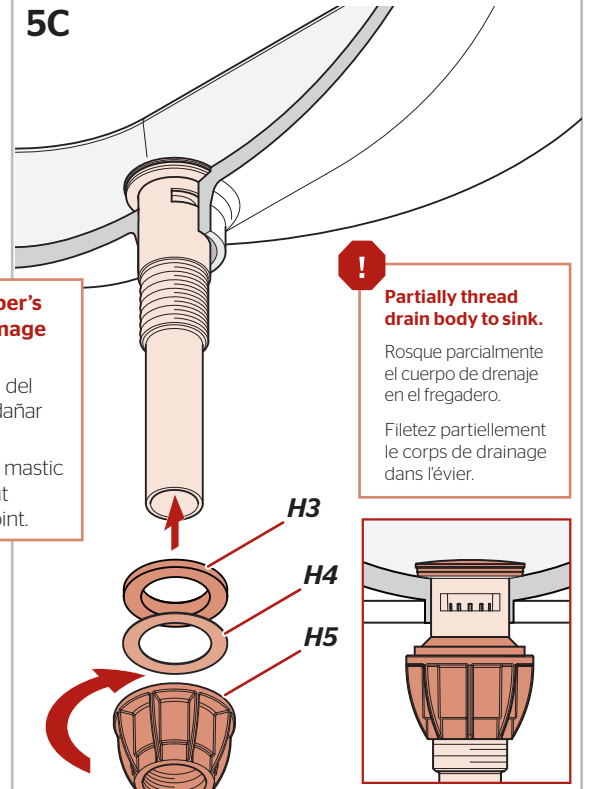

**Partially thread drain body to sink.**  
 Rosque parcialmente el cuerpo de drenaje en el fregadero.  
 Filetez partiellement le corps de drainage dans l'évier.

#### 5D

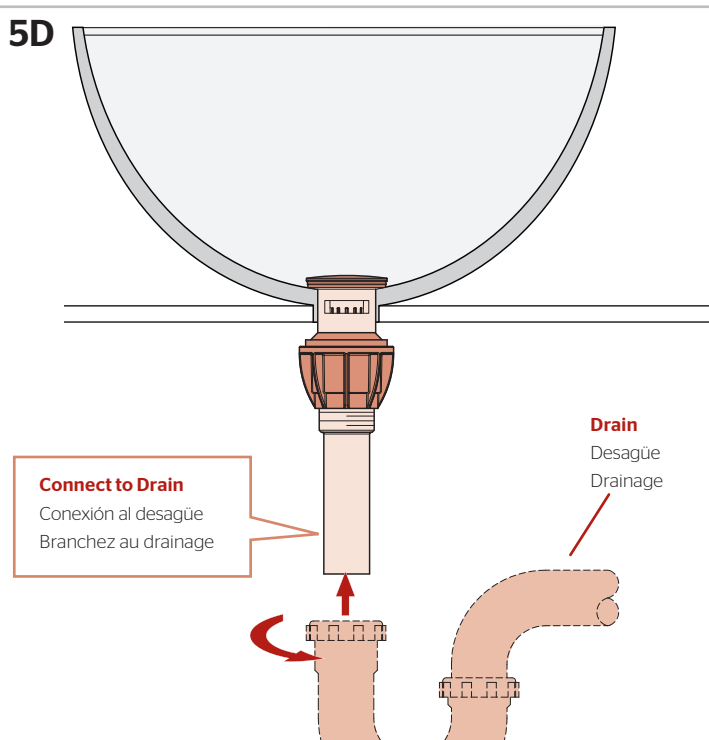

**Connect to Drain**  
 Conexión al desagüe  
 Branchez au drainage

**Drain**  
 Desagüe  
 Drainage

#### 5E

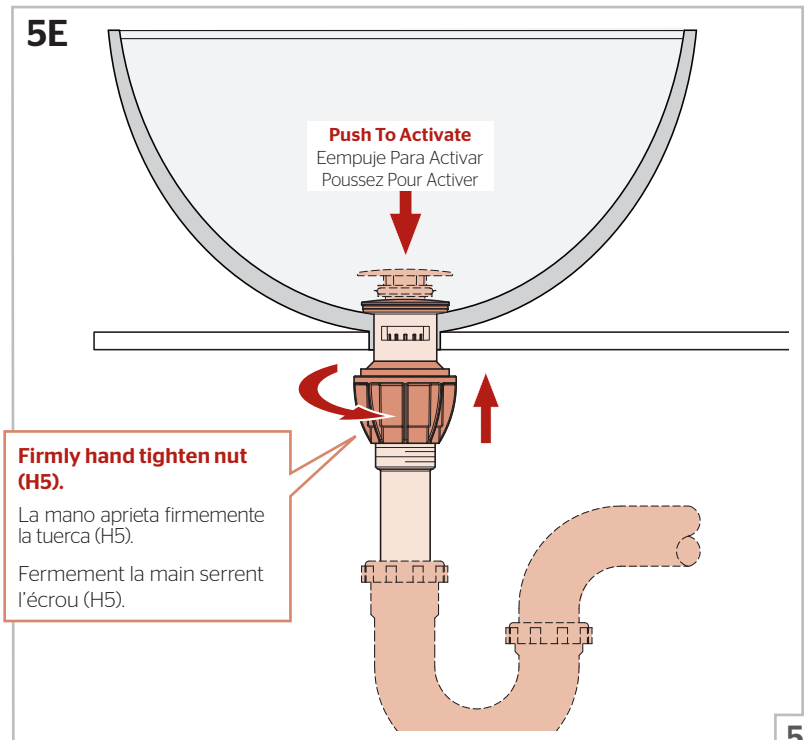

**Push To Activate**  
 Empuje Para Activar  
 Poussez Pour Activer

**Firmly hand tighten nut (H5).**

La mano aprieta firmemente la tuerca (H5).  
 Fermelement la main serrent l'écrou (H5).

## 6 Turn On Water & Confirm Proper Installation

Active el suministro de agua y confirme que la instalación está adecuadamente efectuada

Ouvrez l'eau et confirmez que l'installation est correcte

### 6A

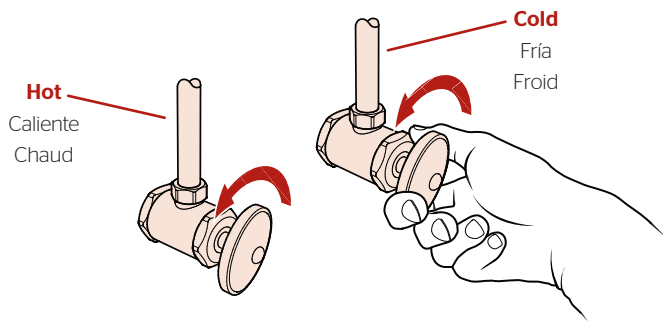

#### Check for leaks above and below the sink.

Revise si hay fugas encima y debajo del fregadero

Assurez-vous qu'il n'y a pas de fuite au dessus ou au dessous du lavabo.

## 7 Faucet Function

Funciones del grifo

Fonctionnement du robinet

### 7A

**Open**  
Abierta  
Ouvverte

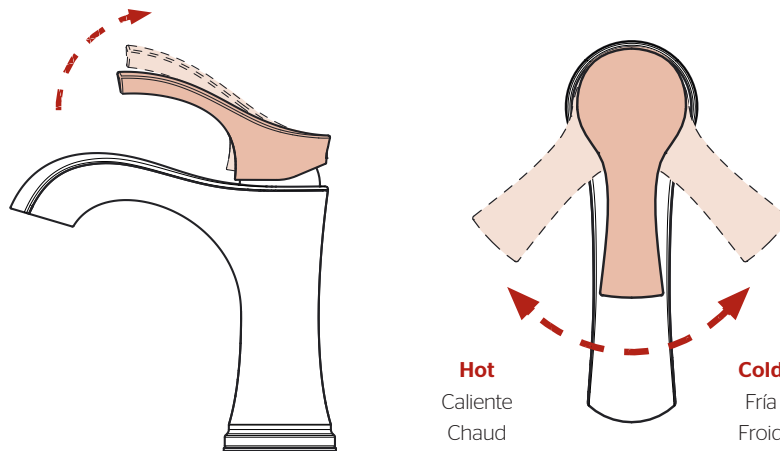

## 8 Flush the Faucet

Enjuague el grifo

Vidanger l'robinet

### 8A Remove Aerator

Retire el aereador  
Retirez l'aérateur

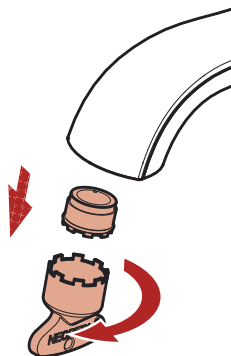

### 8B



#### Allow hot & cold water to run for at least 15 seconds each.

Deje correr el agua caliente y fría durante al menos 15 segundos cada una.

Laissez couler l'eau chaude et l'eau froide pendant au moins 15 secondes.

### 8C Reinstall Aerator

Reinstale el aereador  
Réinstallez l'aérateur

#### Hand Tighten

Apriete con la mano  
Serrez manuellement

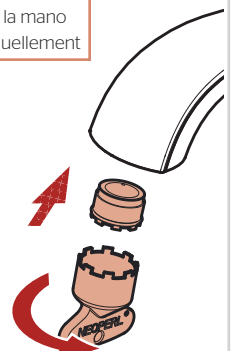

For Additional Installation Help:

Para la instalación adicionales de ayuda:

Pour les aides supplémentaires à l'installation:

**Pfister**

1-800-PFAUCET (732-8238)  
pfisterfaucets.com